



High Voltage Doorknob Capacitor 10KV to 150KV System Voltages



DONGGUAN AMAZING ELECTRONIC CO., LTD. focus on the high voltage capacitor field since 2001, with over 20 patents. This doorknob type of capacitors are widely used in high power high impulse supplies, particle accelerators, electromagnetic microwave equipment, laser photoelectric equipment, electronic equipment, radar detection, non destructive testing, electrostatic dust removal equipment, material testing, various types of special pulse power supplies, etc.

High Voltage Doorknob Capacitor 10KV to 150KV System Voltages

Features	Applications
<ul style="list-style-type: none"> ■ Low dissipation factor of 1% at 1 KHZ ■ High frequency $\geq 100\text{KHZ}$ ■ High current $\geq 15\text{mA}$ ■ High voltage $\geq 2U_n$ ■ High insulation resistance $\geq 100000\text{M}\Omega$ ■ Long life ≥ 10 years 	<ul style="list-style-type: none"> ■ High frequency & high voltage power supplies ■ CO2 lasers, high voltage pulse generator ■ X-ray equipment ■ NDT (Non-destructive testing) ■ Airport security equipment ■ Capacitance 20PF~20000PF ■ Voltage 10KVDC~200KVDC

MZCT8GDL20KV501K

Capacitance (PF)	Ceramic Dielectric	Rated Voltage (KVDC)	Capacitance (PF)	TOL (%)	D (mm)	T (mm)	F (mm)
MZCT8GDL20KV501K	N4700	20	500	10	30	26	31

Note: Can provide customization

High Voltage Doorknob Capacitor 10KV to 150KV System Voltages

Dimension & Style

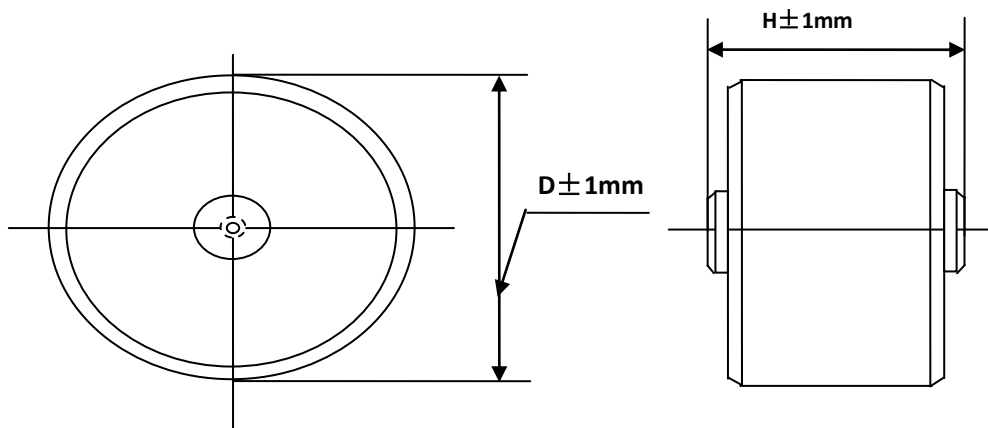

About N4700 Ceramic

N4700 ceramic capacitor is successfully developed in recent years, a new type of ceramic, a ceramic material widely used in high-end products, compared to other Class I ceramic dielectric constant large, suitable for larger capacitance, resistance higher voltage, dissipation factor less than 0.2%, much lower than the average class II ceramic; insulation resistance is greater than $200000\text{M}\Omega$, better frequency and characteristics of the temperature coefficient, withstand greater current, Its temperature variation of capacitance is within $\pm 28\%$ from -25°C to $+85^\circ\text{C}$, it is life of more than 10 years.

About D (Y Series) Ceramic

Y5T/ Y5U/ Y5V is a better performance of Class II General Ceramic. Its temperature variation of capacitance is within $+22/-33\%$ from -25°C to $+85^\circ\text{C}$. Dissipation factor is less than 1%, insulation resistance greater than $100000\text{M}\Omega$.

High Voltage Doorknob Capacitor 10KV to 150KV System Voltages

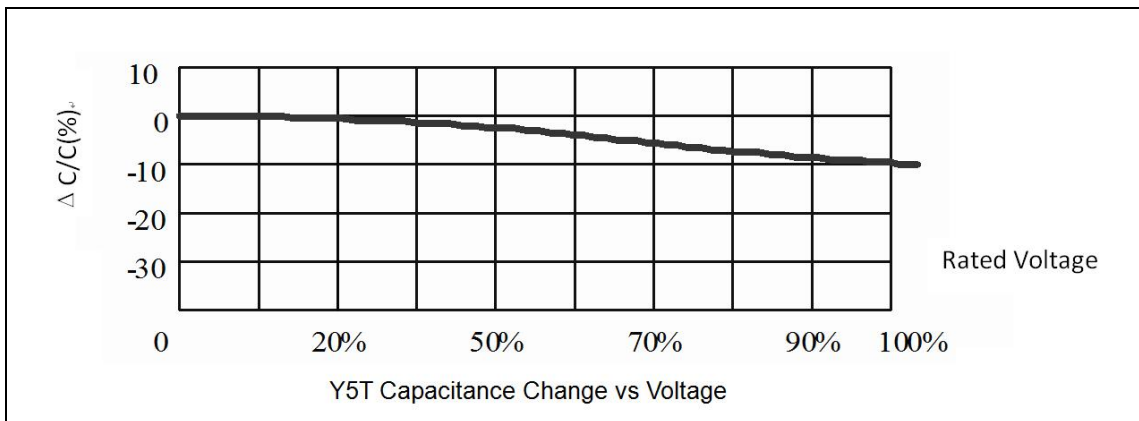
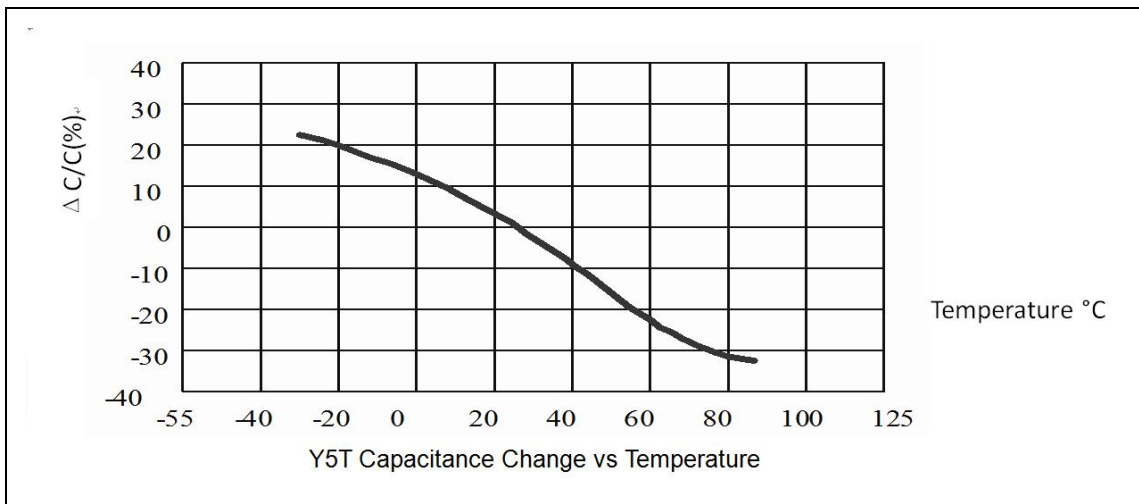
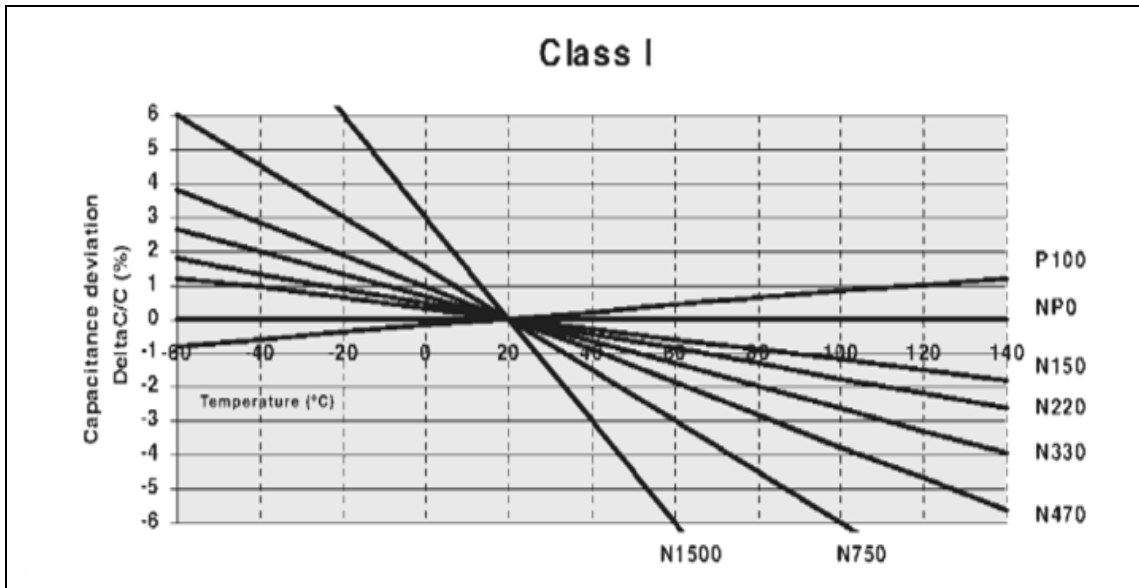

Notes:**(1) During transportation and storage**

- Do not transport or store where the capacitor will be exposed to high temperature or high humidity.
- Do not expose to poisonous gases such as H_2SO_4 , HCL or HNO_3 .
- Avoid excessive impact such as that caused by falling.

(2) During operation

- Avoid contact with electrolytes such as perspiration. Do not touch with bare hands.
- Avoid excessive impact such as that caused by falling.
- Do not apply solder to stud terminals.
- Do not re-machine the terminals.

(3) Usage

- When the capacitor is used for high-speed pulses such as with a laser, make sure that the impressed voltage (peak-to-peak volt-age) is within the capacitor's rated specifications.
- Make sure that the capacitor is not exposed to radiant heat.